

# Calendrier des vacances

## JUILLET 2026

LUNDI	MARDI	MERCREDI	JEUDI	VENDREDI	SAMEDI	DIMANCHE
		1	2	3 VACANCES	4	5
6	7	8	9	10	11	12
13	14	15	16	17	18	19
20	21	22	23	24	25	26
27	28	29	30	31		

## AOUT 2026

LUNDI	MARDI	MERCREDI	JEUDI	VENDREDI	SAMEDI	DIMANCHE
					1	2
3	4	5	6	7	8	9
10	11	12	13	14	15	16
17	18	19	20	21	22	23
24	25	26	27	28	29	30
31						

**MARDI 1<sup>ER</sup> SEPTEMBRE  
RENTRÉE AU CP**

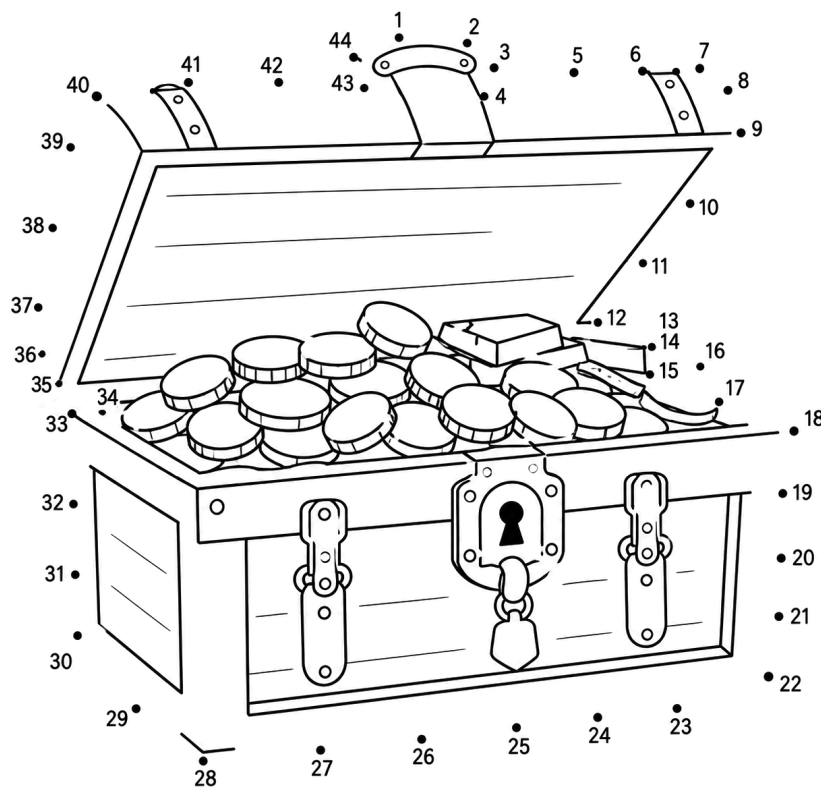

Z	E	C	O	F	F	R	E	H
N	W	Q	C	A	R	T	E	G
P	E	R	R	O	Q	U	E	T
T	P	A	L	M	I	E	R	B
V	A	P	C	L	É	S	T	U
I	R	P	I	È	C	E	O	D

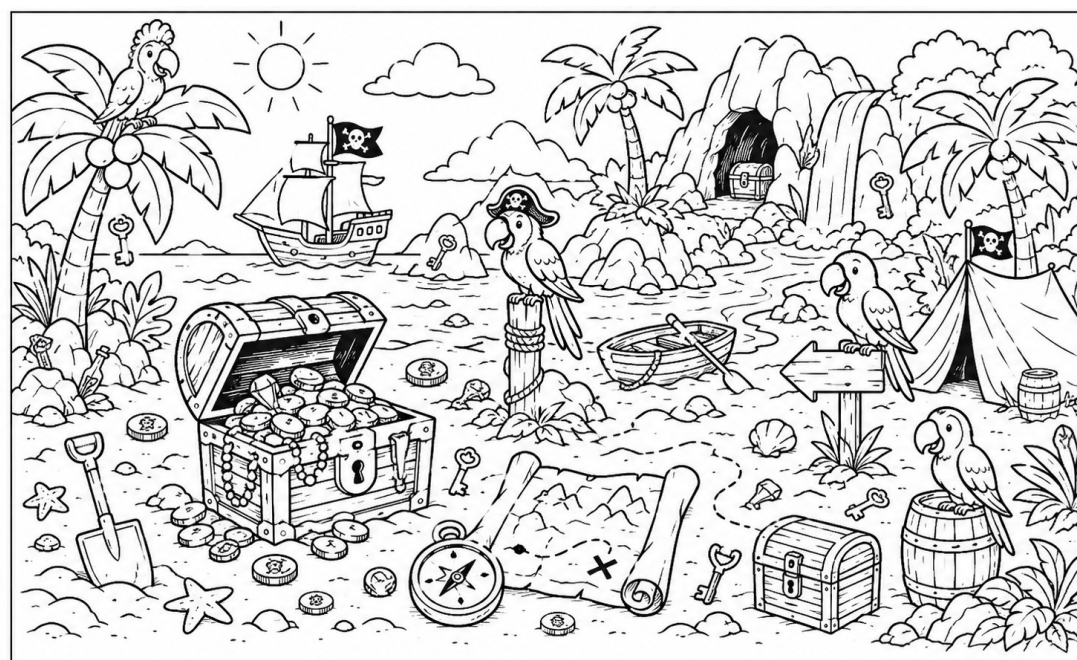
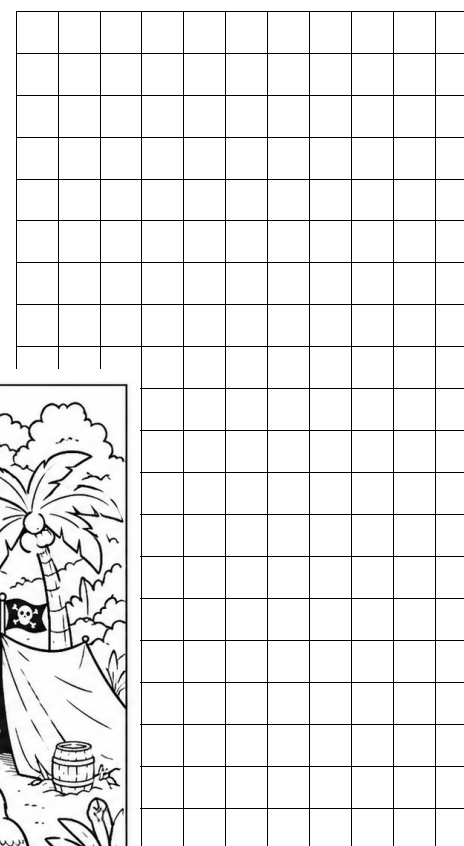

# JUILLET 2026

LUNDI	MARDI	MERCREDI	JEUDI	VENDREDI	SAMEDI	DIMANCHE
		1	2	3 VACANCES	4	5
6	7	8	9	10	11	12
13	14	15	16	17	18	19
20	21	22	23	24	25	26
27	28	29	30	31		

# AOUT 2026

LUNDI	MARDI	MERCREDI	JEUDI	VENDREDI	SAMEDI	DIMANCHE
					1	2
3	4	5	6	7	8	9
10	11	12	13	14	15	16
17	18	19	20	21	22	23
24	25	26	27	28	29	30
31						

**MARDI 1<sup>ER</sup> SEPTEMBRE  
RENTRÉE AU CP**

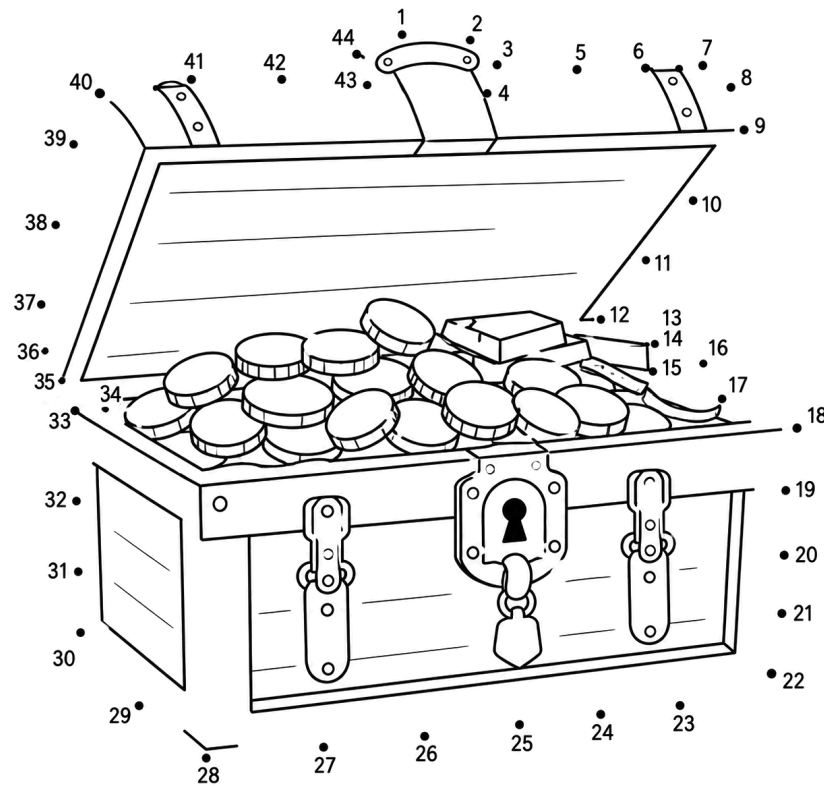

Z	E	C	O	F	F	R	E	H
N	W	Q	C	A	R	T	E	G
P	E	R	R	O	Q	U	E	T
T	P	A	L	M	I	E	R	B
V	A	P	C	L	É	S	T	U
I	R	P	I	È	C	E	O	D

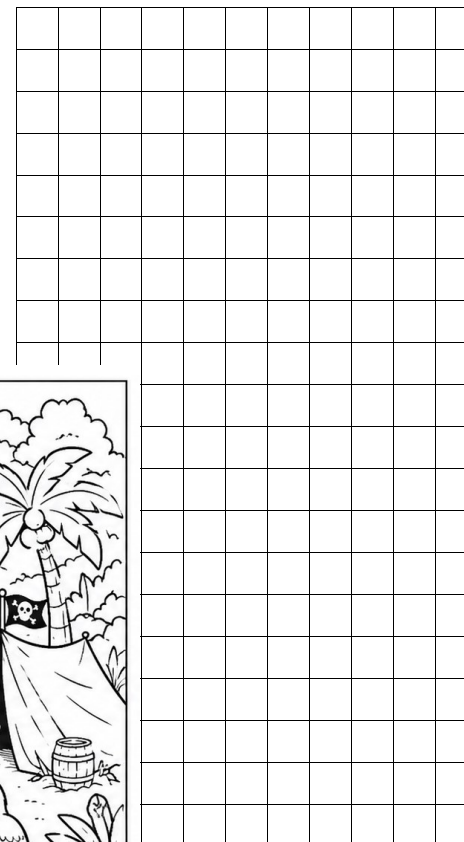

# JUILLET 2026

LUNDI	MARDI	MERCREDI	JEUDI	VENDREDI	SAMEDI	DIMANCHE
		1	2	3 VACANCES	4	5
6	7	8	9	10	11	12
13	14	15	16	17	18	19
20	21	22	23	24	25	26
27	28	29	30	31		

# AOUT 2026

LUNDI	MARDI	MERCREDI	JEUDI	VENDREDI	SAMEDI	DIMANCHE
					1	2
3	4	5	6	7	8	9
10	11	12	13	14	15	16
17	18	19	20	21	22	23
24	25	26	27	28	29	30
31						

**MARDI 1<sup>ER</sup> SEPTEMBRE  
RENTRÉE AU CE1**

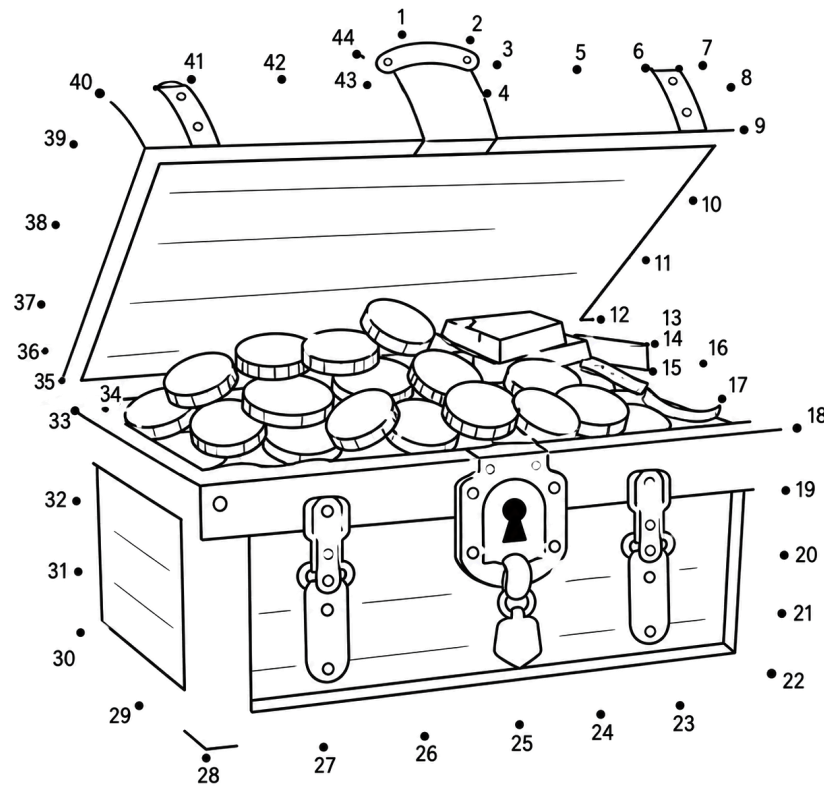

F	C	A	R	T	E	T	P	X
Q	O	R	V	C	G	U	I	S
J	F	P	A	L	M	I	E	R
D	F	R	N	E	M	S	C	G
L	R	A	Q	F	T	K	E	U
P	E	R	R	O	Q	U	E	T

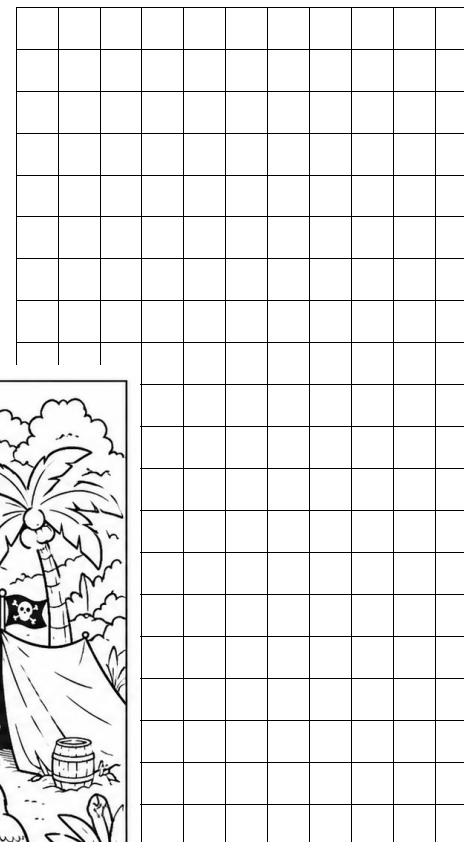

Calendrier des vacances

Calendrier des vacances

Calendrier des vacances

Calendrier des vacances

Calendrier des vacances

Calendrier des vacances

Calendrier des vacances

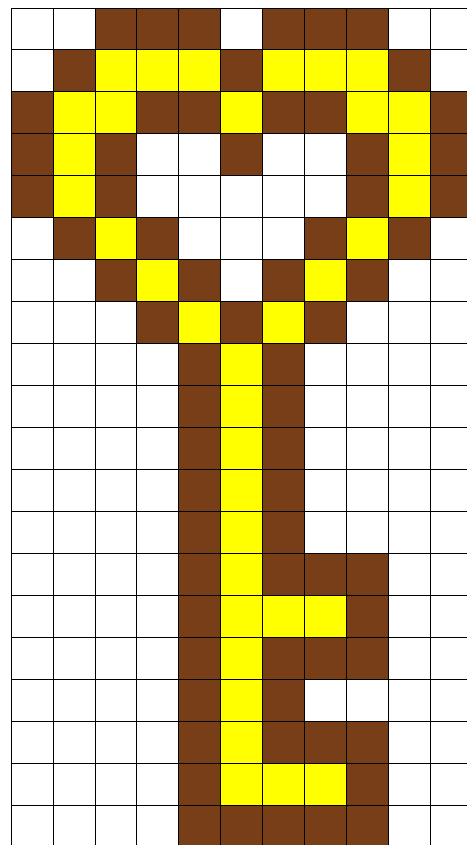
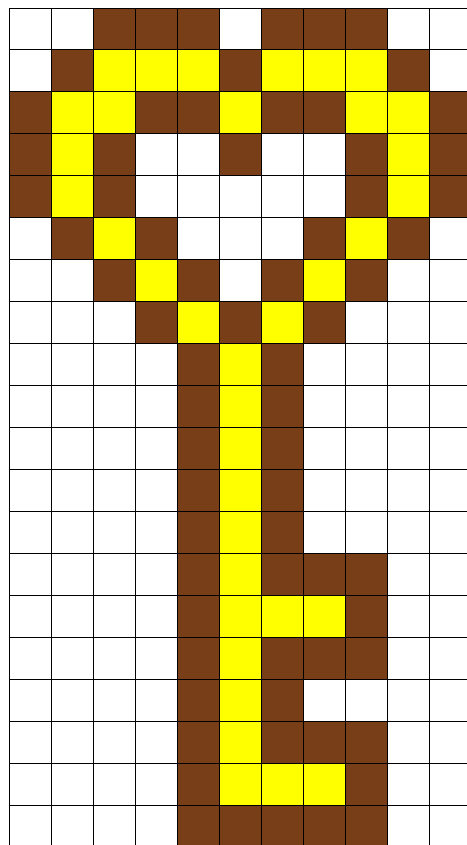
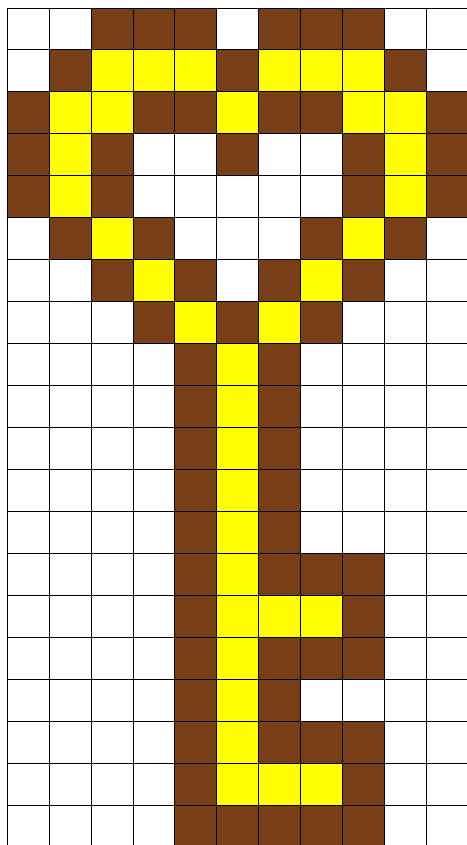
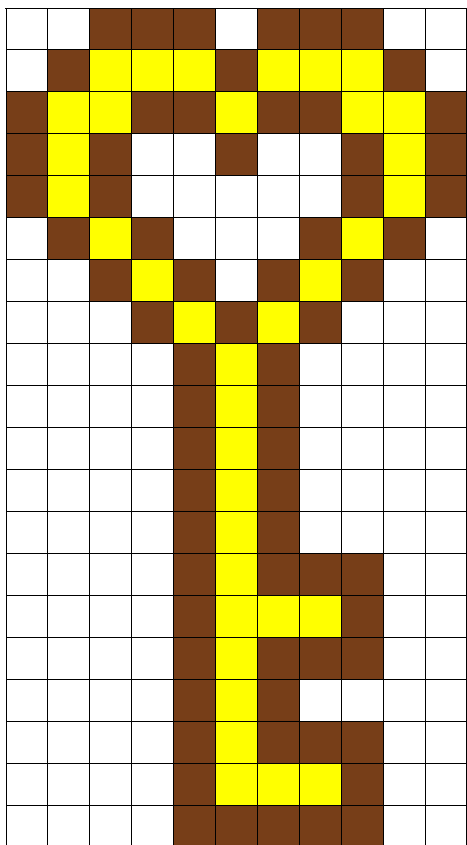
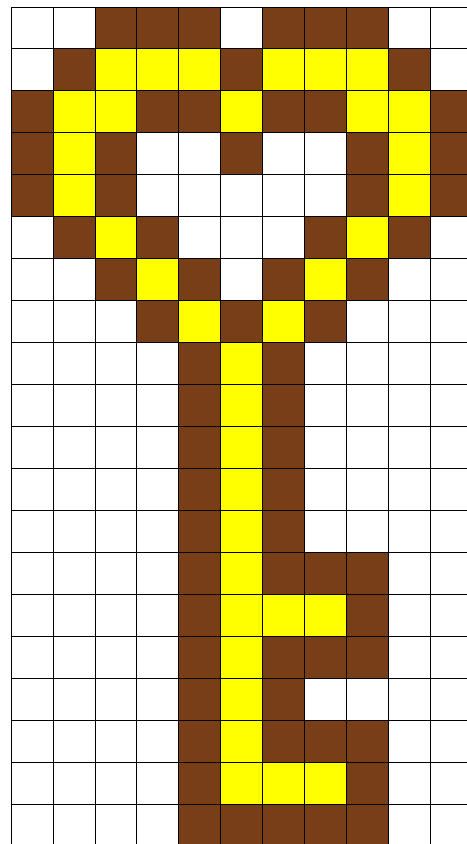
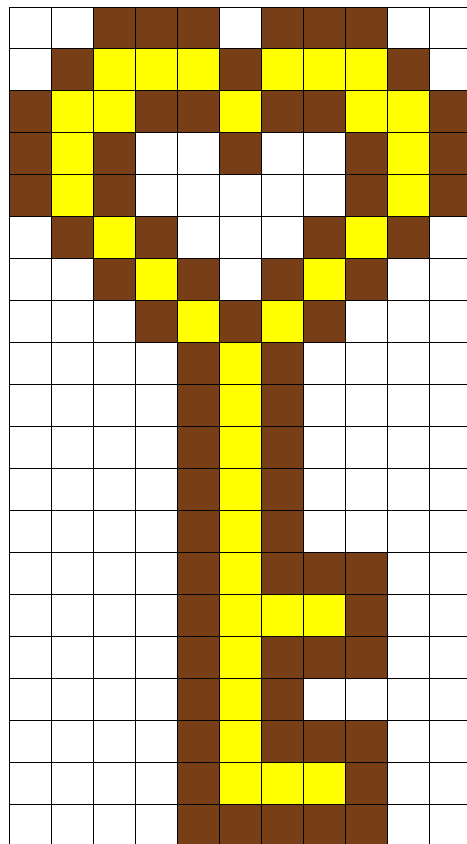
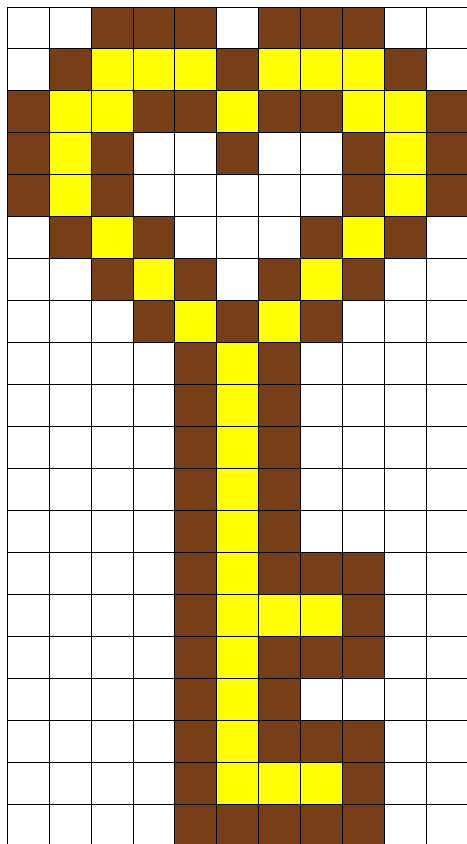
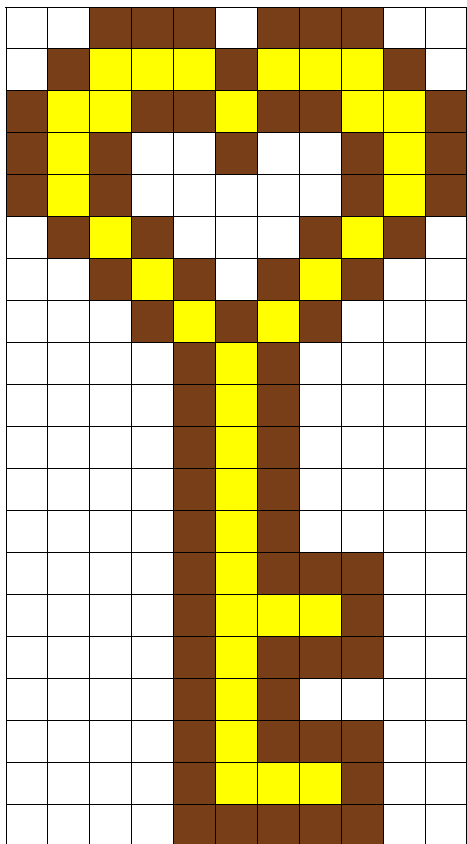

### Cherche et trouve - Mots cachés



perroquet



carte



palmier



coffre

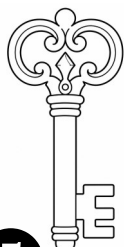

clé

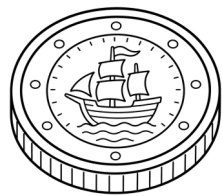

pièce

### Cherche et trouve - Mots cachés



perroquet



carte



palmier



coffre

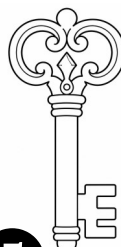

clé

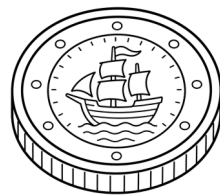

pièce

### Cherche et trouve - Mots cachés



perroquet



carte



palmier



coffre

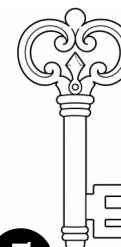

clé

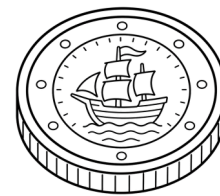

pièce

### Cherche et trouve - Mots cachés



perroquet

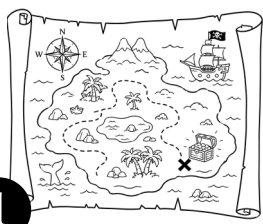

carte

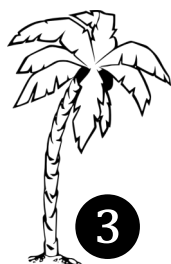

palmier



coffre

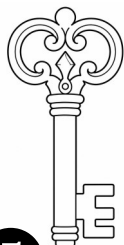

clé

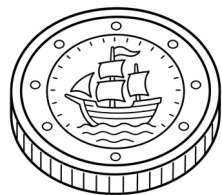

pièce

### Cherche et trouve - Mots cachés



perroquet

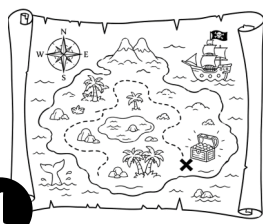

carte



palmier



coffre

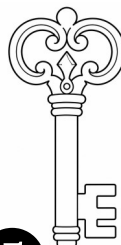

clé

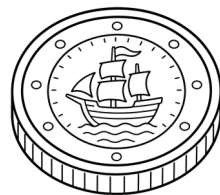

pièce

### Cherche et trouve - Mots cachés



perroquet

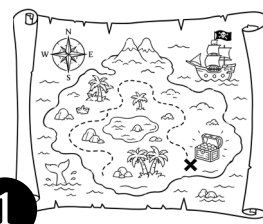

carte



palmier

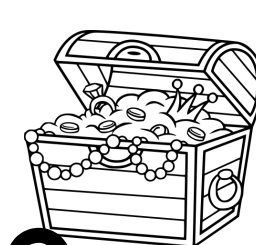

coffre

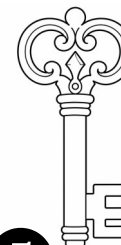

clé

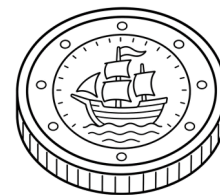

pièce